



AERDIESEL

CONTINUOUS IMPROVEMENT

**AMERICAN
APPLICATIONS**

**2022
V2**

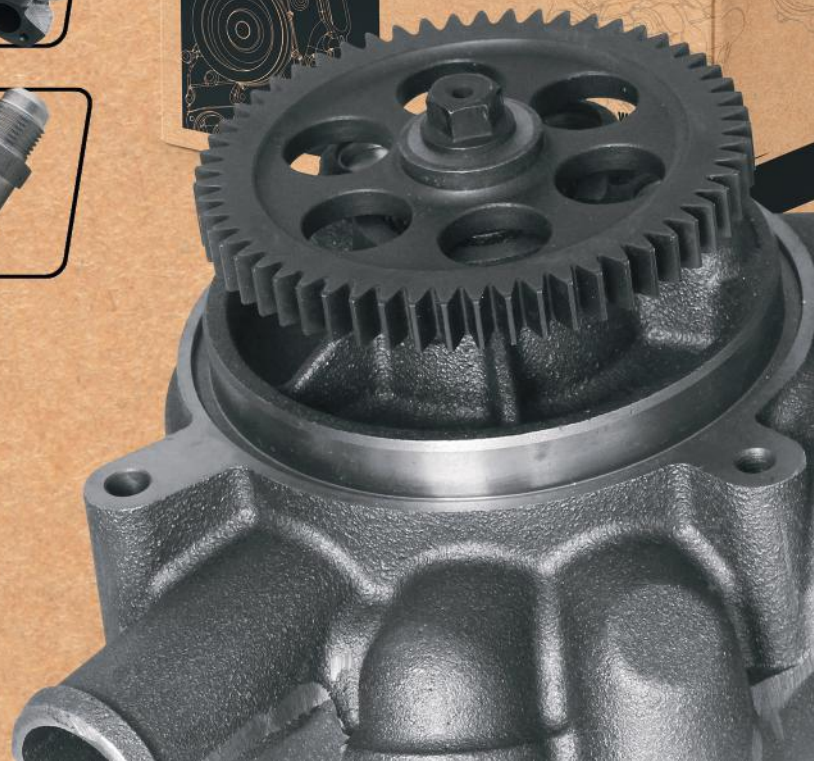

**CATALOGO DE PRODUCTOS
CATÁLOGO DE PRODUTOS
PRODUCT CATALOGUE**



AERDIESEL

CONTINUOUS IMPROVEMENT



AERDIESEL

CONTINUOUS IMPROVEMENT

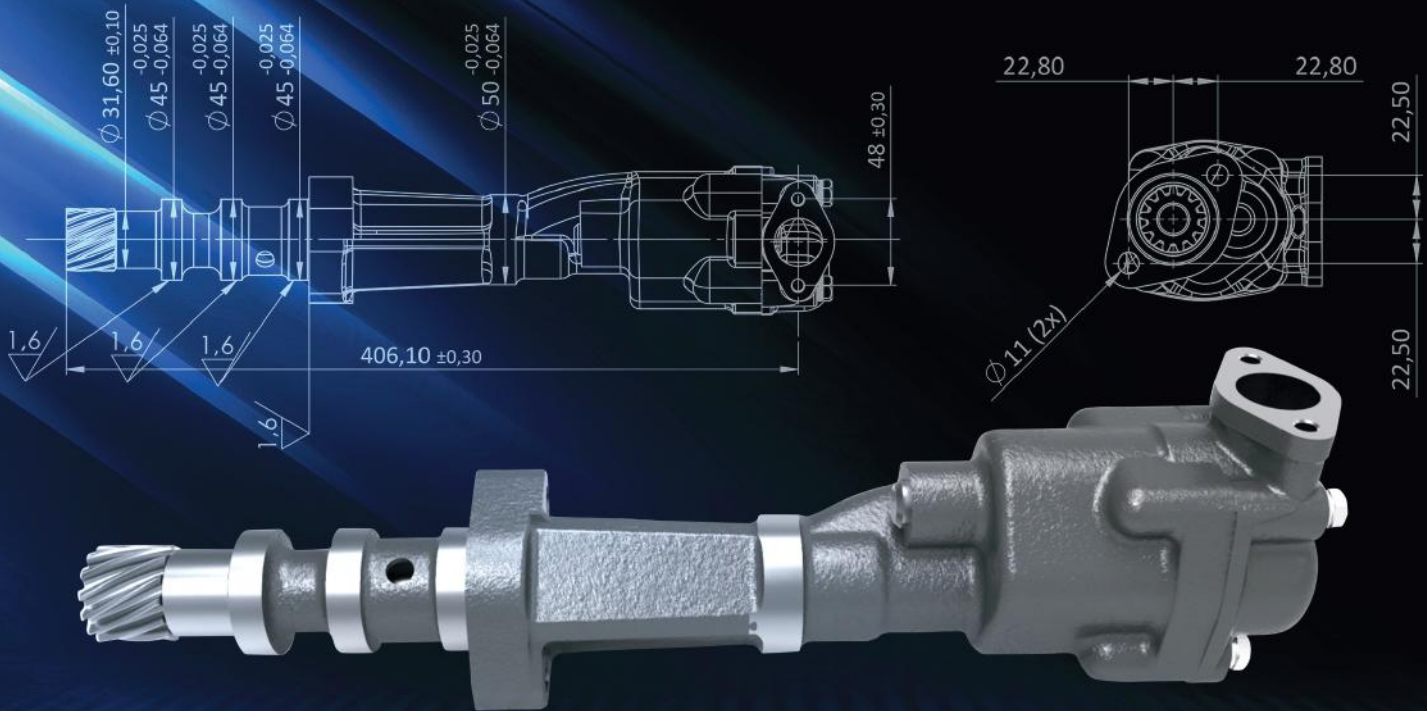



AERDIESEL

CONTINUOUS IMPROVEMENT





AERDIESEL

CONTINUOUS IMPROVEMENT

CONTINUOUS IMPROVEMENT

Oil Pumps - Water Pumps - Relief Valves - Fuel Pumps

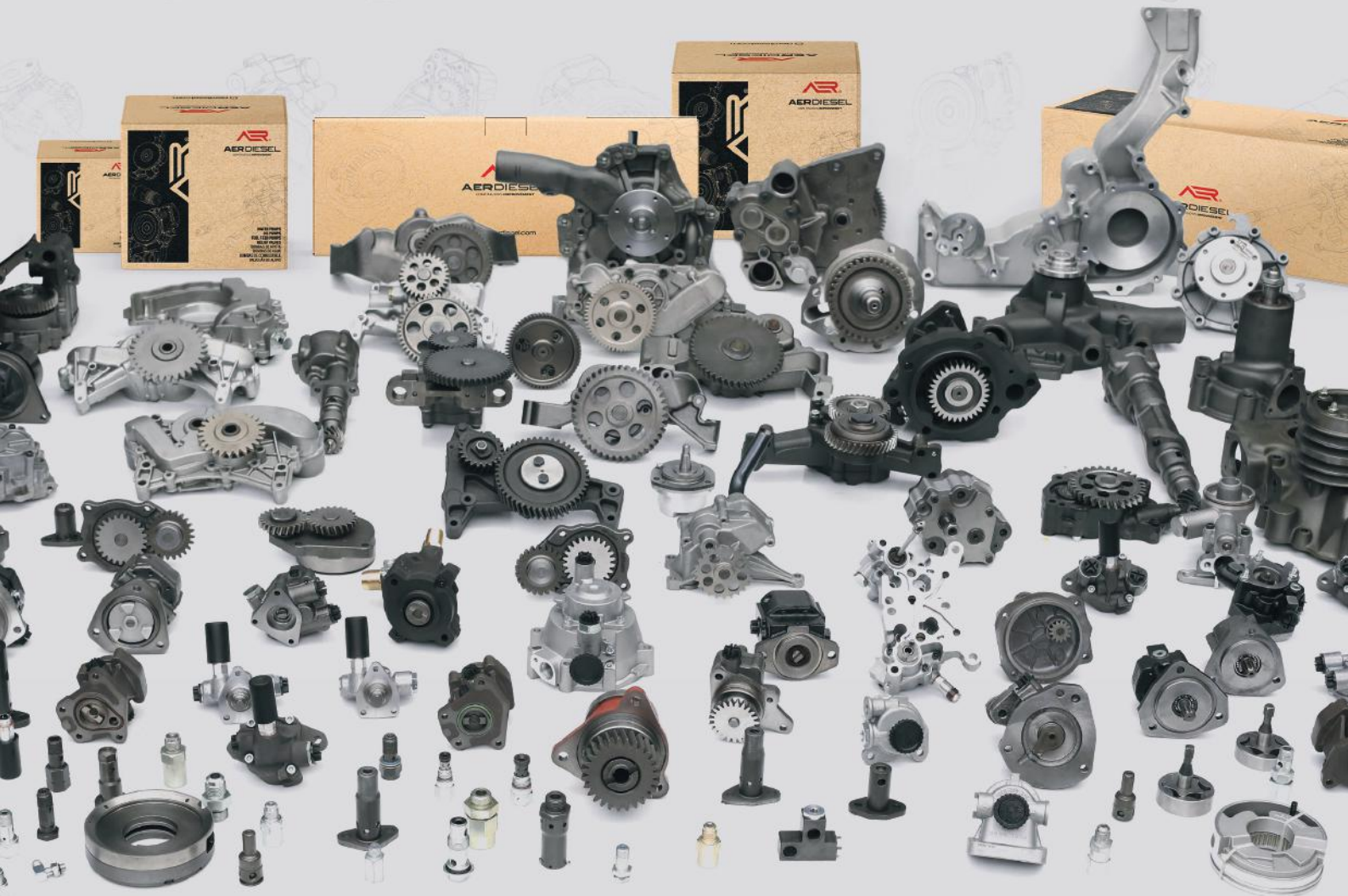







AERDIESEL
CONTINUOUS IMPROVEMENT

CATERPILLAR

 aerdiesel.com

	COMP. NO	MODEL	AERDIESEL
	613890 OR4120 1354925 OR8218 OR8330	3406 E	AW38010 CATERPILLAR
	10R0484 OR9869 1615719 3520211	3406E / C15 / C16 / C18 Series	AW38020 CATERPILLAR
	7C4957 OR8217 7W7019 10R0482 1354926 9N5035	3406A / 3406B / 3406C application	AW38030 CATERPILLAR
	2243239 10R3326 10R6225 10R8660	C15 / C16 / C18	AW38040 CATERPILLAR
	2923751	320D 312D 314D 319D 311D 315D	P124 CATERPILLAR

	COMP. NO	MODEL	AERDIESEL
	3186357	3176 / C9 / C10 / C11 / C12 / C13 Series	FP126 CATERPILLAR
	2447010021SS	REPAIR KIT DIAMETER : 24.00 MM THREAD : 1/4-18NPTF	FP112 BOSCH
	2447010043	REPAIR KIT DIAMETER : 22.00 MM THREAD : 14.00 mm x 1.50 mm	FP113 BOSCH
	2447010021S	REPAIR KIT DIAMETER : 22.00 MM THREAD : 14.00 mm x 1.50 mm	FP114 BOSCH
	2447010004		FP115 BOSCH



AERDIESEL

CONTINUOUS IMPROVEMENT





CUMMINS

 aerdiesel.com

	COMP. NO	MODEL	AER DIESEL
	5313086 5273937 4939586 4897480 3976087	ISB / QSB Series Application	OP14001 CUMMINS
	5291050 4939588 4897481 3971544	ISB / QSB Series Application	OP14002 CUMMINS
	4939585 3937027 3930336 3926202 3924719	4B Series Application	OP14004 CUMMINS
	3930338 3924644 3802278 3800828 3358060	6C / ISC / ISL Series Application	OP14005 CUMMINS
	3947308 4988801 3973398 3957266	ISB / QSB Application	OP14007 CUMMINS

	COMP. NO	MODEL	AER DIESEL
	<p>5266566 4983588 3991123 3966840</p>	<p>6C / ISC / ISL Series Application</p>	<p>OP14003 CUMMINS</p>
	<p>4939587 3941742 3937404 3930337 3926203 3918212 3914006</p>	<p>6B Series Application</p>	<p>OP14006 CUMMINS</p>
	<p>2881757 4309500</p>	<p>ISX Aluminium</p>	<p>OP14010 CUMMINS</p>
	<p>5532492</p>	<p>ISX / ISX 15 Engine Series Application</p>	<p>OP14013 CUMMINS</p>
	<p>3803698 3074196 3609832 3609835</p>	<p>N14 Straight Gear</p>	<p>OP14008 CUMMINS</p>





	COMP. NO	MODEL	AERDIESEL
	3803369 3068460	N14 Helical Gear	OP14009 CUMMINS
	3821572 3609837 3077770 3821575 3045882	855 Big Cam DFC	OP14011 CUMMINS
	AR10172	855 High Pressure	OP14012 CUMMINS
	3047549	K19 Series 30 Gear Teeth	OP14015 CUMMINS
	4003950	L10 / M11 / ISM Series	OP14016 CUMMINS

	COMP. NO	MODEL	AER DIESEL
	3801708 AR45217 3045943 3004923	NT855 Big Cam IV 855 (Multi-Groove pulley) Vented	AW34010 CUMMINS
	3801784 3000886 AR45080 AR45090	855 Small Cam FFC (2 Groove pulley)	AW34190 CUMMINS
	3804826	N14 Application Low Fan Mount	AW34370 CUMMINS
	AR45184 3022474 3801788	Big Cam I, II, 855 Models NTC290 NTC350, NTC400	AW34020 CUMMINS
	3803605 3803361 3067998 3076529	N14 Series	AW34070 CUMMINS

	COMP. NO	MODEL	AER DIESEL
	3027174	Big Cam III	AW34030 CUMMINS
	3022471 4919820 3007338	Small Cam 855 Series	AW34430 CUMMINS
	AR61788 4919812	V8-210	AW34440 CUMMINS
	3062928 3803138 3803030 3052386	88 Big Cam IV NT88, NTC300, 315, 350, 365, 400	AW34040 CUMMINS
	3684450 3683651 3684449	ISX, ISZ (12 groove pulley only)	AW34050 CUMMINS

	COMP. NO	MODEL	AER DIESEL
 	34079-B05	Dina 155/210 Rear	AW34250 CUMMINS
 	4299042 3803403 3073696	L10E, M11, ISM Series L10, M11 ISM / QSM Series	AW34060 CUMMINS
 	3800745	ISM / M11 Application	AW34470 CUMMINS
 	4089908	ISX Series (10 groove pulley)	AW34080 CUMMINS
 	4089909	ISX Series (11 groove pulley)	AW34090 CUMMINS

	COMP. NO	MODEL	AER DIESEL
	4089910 4089158	ISX Series (12 groove pulley)	AW34100 CUMMINS
	3684449 3683652	ISX, ISZ (12 groove pulley) Complete unit (Short bottom outlet)	AW34350 CUMMINS
	4386570 3687130 5406043	ISX, ISZ (12 groove pulley) Complete unit (Long bottom outlet)	AW34360 CUMMINS
	2881688	4.5L, 6.7L ISB Series 94.25 MM pulley Gas	AW34130 CUMMINS
	3286277 3003749 3913432 3802358 3802004 3802970	B Series New Style	AW34150 CUMMINS

	COMP. NO	MODEL	AER DIESEL
	3286278 3285410 3285414	B Series New Style ISB Engine	AW34160 CUMMINS
	3286276	B Series New Style ISB Engine 76MM pulley	AW34170 CUMMINS
	3800974 3926912 3923568 3285323	C Series Long Nose	AW34200 CUMMINS
	4955394	ISB Series (Bus)	AW34270 CUMMINS
	3913430 3802081 3804883	C Series Short Nose	AW34230 CUMMINS





	COMP. NO	MODEL	AER DIESEL
	3806180 F3HZ 8501-B	ISX Series (12 groove pulley)	AW34100 CUMMINS
	3286293 3973114 3940052	ISC / ISL	AW34280 CUMMINS
	4376357	ISC, ISL, QSC, QSL 76MM Pulley	AW34290 CUMMINS
	4309417 4376358 4089952	ISC, ISL, QSC, QSL 88.25MM Pulley	AW34300 CUMMINS
	4309429 68210961AA	13-15 Dodge Ram Trucks 6.7L ISB / QSB APP 6.7L	AW34120 CUMMINS

	COMP. NO	MODEL	AERDIESEL
	3800984 4891252	ISB Series	AW34260 CUMMINS
	4089647	6C/ISC/ISL Application	AW34480 CUMMINS
	3800883	B3.3 / QSB 4.5 Gen. Set	AW34180 CUMMINS
	4955709 4089455	ISM / QSM Water Pump (EGR) Long Shaft	AW34310 CUMMINS
	4955708 4089389 4972842	ISM M11 & L10 Short shaft	AW34320 CUMMINS

	COMP. NO	MODEL	AER DIESEL
	3803402 3801840 3056083	4 Hole Flange Mount L10 Series	AW34330 CUMMINS
	4955707 3800954	M11 & L10 Short shaft 3 Hole Flange Mount	AW34340 CUMMINS
	BM76506 BM75893	743 Series	AW34380 CUMMINS
	AR4284 4919813 4920086	855 Series With pulley	AW34390 CUMMINS
	AR4283 4919814 196845	855 Series Without pulley	AW34400 CUMMINS

	COMP. NO	MODEL	AER DIESEL
	AR51360 4919815	ISB Series	AW34260 CUMMINS
	5257960	ISF3.8 Engine	AW34450 CUMMINS
	3352550 0440003243 0440003238	NT855	FP024 CUMMINS BOSCH
	3092731 0440008113		FP063 CUMMINS BOSCH
	440008137		FP080 CUMMINS BOSCH





	COMP. NO	MODEL	AERDIESEL
	4935092 5362253	ISX, ISB, QSB SERIES ENGINE	FP131 CUMMINS
	5362255	ISX/QSX ENGINES	FP132 CUMMINS
	4088866 2872545	ISL Series Engine Application	FP091 CUMMINS
	3005133 3005126	NT855 N14	FP102 CUMMINS
	4089163	QSX15/ISX15	FP135 CUMMINS

	COMP. NO	MODEL	AER DIESEL
	4089431 4088848 4076574 3348700 3348701	ISX / ISX 15 Engines Application	FP136 CUMMINS
	4988748	ISB/QSB application	FP090 CUMMINS
	3936319 3933255 3918000 3930202 3932227 3936319	6B-5.9 / 6C-8.3 Engines Application	FP104 CUMMINS
	4944710	6C/ISC/ISL Series Engine Application	FP106 CUMMINS
	3936316 4988747 3925709 3930134	6C/ISC/ISL Series Engine Application	FP105 CUMMINS

	COMP. NO	MODEL	AER DIESEL
	4988749	6C/ISC/ISL Series Engine Application	FP117 CUMMINS
	3065000	NT88 855 Series	ID000 CUMMINS
	3062931 3081234	NT88 855 Series	ID931 CUMMINS
	3066330	N14 Series	ID330 CUMMINS
	3062602 3034969	ISM, L10, M11 Application	ID602 CUMMINS

	COMP. NO	MODEL	AERDIESEL
	3064919 AR45189 3051348	855 Series Big Cam I, II, III Early Big Cam IV	ID919 CUMMINS
	3064920 AR8851	Small Cam FFC 855 Series	ID920 CUMMINS
	11100110035		RV064 CUMMINS BOSCH
	4899831 F00R000775 BG5X9F479BA ZR0201136B		RV065 CUMMINS BOSCH
	3963808		RV069 CUMMINS

	COMP. NO	MODEL	AER DIESEL
	3945967		RV090 CUMMINS
	3974093 1110010015 1110010028		RV091 CUMMINS
	3947799 3963808		RV092 CUMMINS
	4307376		RV093 CUMMINS
	4001926		RV094 CUMMINS

	COMP. NO	MODEL	AER DIESEL
	3348332		RV095 CUMMINS
	3033740	N14 application	RV089 CUMMINS
		REPAIR KIT FOR 4089908	AW34081 CUMMINS
	4090022	ISX (ALUMINIUM)	AW34460 CUMMINS
	2447010021SS	REPAIR KIT DIAMETER : 24.00 MM THREAD : 1/4-18NPTF	FP112 BOSCH

	COMP. NO	MODEL	AER DIESEL
	2447010043	REPAIR KIT DIAMETER : 22.00 MM THREAD : 14.00 mm x 1.50 mm	FP113 BOSCH
	2447010021S	REPAIR KIT DIAMETER : 22.00 MM THREAD : 14.00 mm x 1.50 mm	FP114 BOSCH
	2447010004		FP115 BOSCH







AERDIESEL

CONTINUOUS IMPROVEMENT

DAF

 aerdiesel.com

	COMP. NO	MODEL	AER DIESEL
	683386	Model 85 CF, 95 XF XF 250 280 315	AW21010 DAF
	682968	Model 86 WS 242 286 295	AW21020 DAF
	2447010021SS	REPAIR KIT DIAMETER : 24.00 MM THREAD : 1/4-18NPTF	FP112 BOSCH
	2447010043	REPAIR KIT DIAMETER : 22.00 MM THREAD : 14.00 mm x 1.50 mm	FP113 BOSCH
	2447010021S	PAIT KIT DIAMETER : 22.00 MM THREAD : 14.00 mm x 1.50 mm	FP114 BOSCH

COMP. NO

MODEL

AERDIESEL



2447010004

FP115
BOSCH







AERDIESEL

CONTINUOUS IMPROVEMENT

DETROIT

 aerdiesel.com

	COMP. NO	MODEL	AERDIESEL
	23505886	SERIES 60	OP15001 DETROIT
	23527448	Series 60 EGR	OP15002 DETROIT
	4721803901 4721803101	DD15 Engine	OP15004 DETROIT
	4722000401 4722000701 EA4722000401 RA4722000401 A4722000101 A4722001001	DD13, DD15 (Mechanical)	AW35010 DETROIT
	23538636 23531258 23532543 23535018 23535502	Detroit Diesel Series 60 EGR 14.0L Small Gear	AW35020 DETROIT





	COMP. NO	MODEL	AERDIESEL
	23526039 23539602 R23539929	Detroit Diesel Series 50 / 60 11 liter / 12 liter without EGR Engines	AW35030 DETROIT
	23505895 23520136 23518216	Detroit Diesel Series 60 Application	AW35040 DETROIT
	23535017 23531257 23532542	Detroit Diesel Series 60 Application 12 liter / 14 liter with EGR Engine	AW35050 DETROIT
	23538637	Series 60 12.7L EGR Small Gear	AW35160 DETROIT
	8922335	6 & 8V92	AW35090 DETROIT



	COMP. NO	MODEL	AERDIESEL
	8928672	8.2L (With heater outlet)	AW35100 DETROIT
	23506003 5144685	53 Series (left hand)	AW35060 DETROIT
	23506007 5144686	53 Series (right hand)	AW35070 DETROIT
	23506011 5104392	53 Series Military Aluminum body	AW35080 DETROIT
	23506723	Detroit Diesel Series 71 Application 3 / 4 / 6 Cylinder Left Hand	AW35120 DETROIT

	COMP. NO	MODEL	AERDIESEL
	<p>5149710 23506704</p>	<p>IL 71 LH HI-CAP</p>	<p>AW35130 DETROIT</p>
	<p>23506735</p>	<p>Detroit Diesel Series 71 Application 3 / 4 / 6 Cylinder Right Hand</p>	<p>AW35140 DETROIT</p>
	<p>5149708 23506711</p>	<p>IL 71 RH HI-CAP</p>	<p>AW35150 DETROIT</p>
	<p>23538693</p>	<p>Series 60 EGR 14 Liter Engine</p>	<p>AW35170 DETROIT</p>
	<p>5199560</p>	<p>53/ 71 / 92 LEFT HAND</p>	<p>FP088 DETROIT</p>

	COMP. NO	MODEL	AER DIESEL
	5199561	53/ 71/ 92 RIGHT HAND	FP089 DETROIT
	23535540 23535207	DETROIT ENGINE 2019 SERIES 60	FP092 DETROIT
	23505775	DIESEL 149	FP093 DETROIT
	23523754	SERIES 60 SPLINE DRIVE	FP094 DETROIT
	23532981 23537686 23517845 23505235	SERIES 60	FP111 DETROIT

	COMP. NO	MODEL	AERDIESEL
	08923514 5101816 5101817 5104486	V149	FP127 DETROIT
	5199735	LH, HIGH PRESSURE 12V71, 16V71, 6V92, 12V92, 16V92	FP128 DETROIT
	23536661	60 Series Model-12.7L & 14.0L	FP130 DETROIT
	23516993	SERIES 60	RV071 DETROIT
	23516918	DIESEL SERIES 50/60	RV072 DETROIT

	COMP. NO	MODEL	AER DIESEL
	23516919 23509140	SERIES 60	RV099 DETROIT
	1833386C1	Year: 1993-2003 International DT530E HEUI/DT466E HEUI /530 Engines application	RV110 DETROIT
	23537213	SERIES 60	RV129 DETROIT
	23535129	SERIES 60	RV919 DETROIT
	2447010021SS	REPAIR KIT DIAMETER : 24.00 MM THREAD : 1/4-18NPTF	FP112 BOSCH

	COMP. NO	MODEL	AER DIESEL
	2447010043	REPAIR KIT DIAMETER : 22.00 MM THREAD : 14.00 mm x 1.50 mm	FP113 BOSCH
	2447010021S	REPAIR KIT DIAMETER : 22.00 MM THREAD : 14.00 mm x 1.50 mm	FP114 BOSCH
	23536661		FP115 BOSCH













AERDIESEL

CONTINUOUS IMPROVEMENT

MACK

 aerdiesel.com

	COMP. NO	MODEL	AERDIESEL
	20824906	MP-8	OP7052 MACK
	315GC445G	E6 Engine	OP16001 MACK
	316GC3193 21437575	ASET - 12.0L Diesel 728 5.3" Pulley Mack E7 Series	AW36010 MACK
	316GC3196 21437577 316GC3201 22200630	ASET - 12.0L Diesel 728 5.9" Pulley Mack E7 Series	AW36040 MACK
	316GC3194 316GC3194A	EM7, E7, 6 cyl, 12L Short shaft	AW36020 MACK

	COMP. NO	MODEL	AER DIESEL
	316GC3195	EM7, E7, E-Tech, 6 cyl, 12L Long shaft	AW36030 MACK
	316GC1219 316GC1205 316GC1210 316GC1210A 316GC1210B	Mack E6 2VH, 4VH Short Shaft Long Housing Stamped Impeller	AW36050 MACK
	316GCA184C 316GCA184D 316GCA184E	END-T 675 / 676	AW36060 MACK
	21468472 22197709	MP-7, MP-8, MP-10	AW36070 MACK
	85118917	MP7/MP8	FP006 MACK

	COMP. NO	MODEL	AERDIESEL
	<p>322GC45 044020036 21089217</p>	<p>E7 SERIES</p>	<p>FP052 MACK</p>
	<p>212274R1 1812568C91 0440017040</p>	<p>DT466E HEUI/DT530E HEUI Engines</p>	<p>FP070 MACK NAVISTAR BOSCH</p>
	<p>314GC228AX</p>	<p>E6, E7 1997-2006</p>	<p>FP095 MACK</p>
	<p>440008174</p>	<p>DT-466E / DT-530E (1993-1999 HEUI)</p>	<p>FP096 MACK NAVISTAR</p>
	<p>RBB944800022</p>	<p>E7 SERIES</p>	<p>FP097 MACK</p>

	COMP. NO	MODEL	AERDIESEL
	314GC227 0440008015	E6 SERIES	FP098 MACK
	319GC110 319GC110X	E6 SERIES	FP099 MACK
	314GC227P5 0440008086	E7 SERIES	FP100 MACK
	314GC227P2 0440008030	E6 SERIES	FP101 MACK
	440008120	E-Tech / ASET / E7 Engines applications	FP103 MACK

	COMP. NO	MODEL	AER DIESEL
	<p>1825511C1 1821272C1</p>	<p>DT466E HEUI/DT530E HEUI Engines</p>	<p>RV087 MACK NAVISTAR</p>
	<p>2447010021SS</p>	<p>REPAIR KIT DIAMETER : 24.00 MM THREAD : 1/4-18NPTF</p>	<p>FP112 BOSCH</p>
	<p>2447010043</p>	<p>REPAIR KIT DIAMETER : 22.00 MM THREAD : 14.00 mm x 1.50 mm</p>	<p>FP113 BOSCH</p>
	<p>2447010021S</p>	<p>REPAIT KIT DIAMETER : 22.00 MM THREAD : 14.00 mm x 1.50 mm</p>	<p>FP114 BOSCH</p>
	<p>2447010004</p>		<p>FP115 BOSCH</p>







AERDIESEL

CONTINUOUS IMPROVEMENT

MAN

 aerdiesel.com

	COMP. NO	MODEL	AER DIESEL
	51065006408	Model D2866 D2840 D2066	AW23010 MAN
	51065006547	Model F2000 D2865 D2866	AW23030 MAN
	51065006546	Model D2865 LF24	AW23100 MAN
	51065006616	Model D866	AW23190 MAN
	51065009479	Model F200 D2866 D2865 D2876	AW23200 MAN

	COMP. NO	MODEL	AERDIESEL
	51065007049 51065006637	Model 18.320, 18.350, 18.390, 18.430 TGA D2066 Model D20, D26 With Plastic Impeller	AW23110 MAN
	51065007036	Model D876	AW23160 MAN
	2447010021SS	REPAIR KIT DIAMETER : 24.00 MM THREAD : 1/4-18NPTF	FP112 BOSCH
	2447010043	REPAIR KIT DIAMETER : 22.00 MM THREAD : 14.00 mm x 1.50 mm	FP113 BOSCH
	2447010021S	REPAIR KIT DIAMETER : 22.00 MM THREAD : 14.00 mm x 1.50 mm	FP114 BOSCH

COMP. NO

MODEL

AER DIESEL



2447010004





FP115
BOSCH







AERDIESEL
CONTINUOUS IMPROVEMENT





MERCEDES & FREIGHTLINER



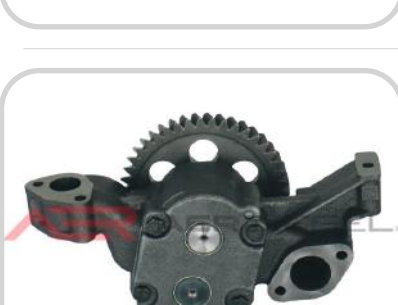

 aerdiesel.com

	COMP. NO	MODEL	AER DIESEL
	3521806301 3141800501 3141801001 3141801701	OM 314 OM 352 OM 352-A (40 mm)	OP4001 MERCEDES
	3661800401 3661800101 3521807701 3521807501	OM 352-A engine OM362LA OM366A (50 mm)	OP4002 MERCEDES
	3661800001 3661800301	OM 366 LA Freightliner (50 mm)	OP4003 MERCEDES FREIGHTLINER
	3521807001 3641800101 3521804201	OM 314 A OM 352 A/H OM 366 (40 mm)	OP4004 MERCEDES
	3551800101	OM 346 A OM 355 OM 355 A OM 355 LA (55 mm)	OP4005 MERCEDES

	COMP. NO	MODEL	AER DIESEL
	3601802401 3601800701 3601800201 3601800601	OM 360 OM 360 A	OP4014 MERCEDES
	3551801601 3451807401	OM 355 A BM 355.969 OM 355 A II BM 355.969 (66 mm)	OP4038 MERCEDES
	9061801101 9061800801 9061800601 9061800401 9061800201	M 906 LAG OM 902 LA OM 904 LA OM 906 LA / HLA OM 924 LA OM 926 LA AXOR / ATEGO	OP4015 MERCEDES
	4031801701 4031803301 4031800601 4011800201 4011800101 4011800001	OM 401 / A / LA OM 402 / A / LA OM 403 OM 407 / A / H / HA / LA OM 409 OM 421 OM 422 / A / LA OM 427 / A / LA	OP4006 MERCEDES
	4031802701	M 447 HG OM 407 AH / H OM 424 A OM 427 H / HA OM 447 H / HA / HLA / HO OM 449 HLA (34 mm)	OP4009 MERCEDES





	COMP. NO	MODEL	AER DIESEL
	4031802801	M 447 HLAG OM 457 HLA (34 mm)	OP4010 MERCEDES
	4231802501 4231802301 4231800501 4231800101	OM 402 / LA OM 403 OM 422 A / LA OM 423 OM 442 A / LA OM 443 (43 mm)	OP4011 MERCEDES
	4571800501 4571800301	M 447 HLAG OM 457 HLA (43 mm)	OP4012 MERCEDES
	4571800801 4571800601	OM 457 LA OM 460 HLA / LA (43 mm)	OP4013 MERCEDES
	5231801101 4571800401 4571800201 4571800001	OM 457 LA OM 460 LA OM 501 LAOM 457 LA OM 460 LA OM 501 LA (43 mm)	OP4031 MERCEDES

	COMP. NO	MODEL	AER DIESEL
	5411800301 5411800201 5411800101 5411800001	OM 501 LA (43 mm)	OP4014 MERCEDES
	5421800701 5421800201 5421800101 5421800001	OM 501 LA OM 502 LA (49 mm)	OP4038 MERCEDES
	5411800401	OM 501 LA OM 502 LA (43 mm)	OP4030 MERCEDES
	5421800401	OM 501 LA OM 502 LA (49 mm)	OP4045 MERCEDES
	4031804501	(38 mm)	OP4040 MERCEDES

	COMP. NO	MODEL	AER DIESEL
	4231801001	OM 404 / A OM 423 / A / LA OM 424 / A / LA OM 443 A / LA OM 444 A / LA (28 mm)	OP4049 MERCEDES
	4231801101	OM 444 A / LA (34 mm)	OP4050 MERCEDES
	4231802601	OM 402.970...996 OM 423.905...909 OM 442.941...999 (43 mm)	OP4042 MERCEDES
	4231800801	OM 423 SERIES (43 mm)	OP4043 MERCEDES
	4011802501	OM 401 / A OM 402 / A OM 403 OM 421-422-423-424 / A / LA OM 441-442 A / LA OM 443 OM 444	OP4047 MERCEDES





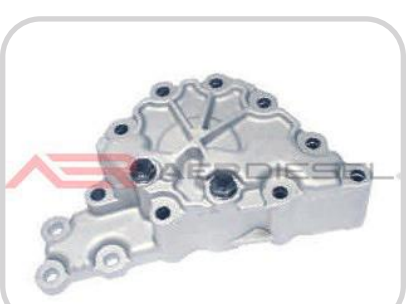

	COMP. NO	MODEL	AERDIESEL
	4231800701	OM 423 SERIES	OP4044 MERCEDES
	5061800001	OM 423 SERIES (43 mm)	OP4054 MERCEDES
	4031803101	(28 mm)	OP4048 MERCEDES
	4571800901	AXOR OM 457 OM 460 LA (49 mm)	OP4052 MERCEDES
	4571801301	AXOR OM 457 OM 460 LA (43 mm)	OP4053 MERCEDES

	COMP. NO	MODEL	AER DIESEL
	5231801701	OM 501 LA (43 mm)	OP4055 MERCEDES
	4601800301	OM 457 LA OM 460 LA (49 mm)	OP4058 MERCEDES
	4601800701		OP4059 MERCEDES
	4031803001	OM 422/423 A/LA	OP4060 MERCEDES
	1315402121 1315402120		OP4021 MERCEDES

	COMP. NO	MODEL	AERDIESEL
	6511802801 6511802601 6511802401 6511801301	SPRINTER VIANO VITO OM651 D1.8 / D2.2	OP4063 MERCEDES
	6511801500 6511802001 6511801501 6511801001 6511801101 6511801801	OM651	OP4100 MERCEDES
	6011801401	SPRINTER 208, 211, 316 CDI, 408 CDI, 411 CDI, VITO 2.2 CDI VITO 108 OM611 (22 mm)	OP4022 MERCEDES
	6021803001	SPRINTER 2.9 D OM602 (27 mm)	OP4023 MERCEDES
	6461801601	SPRINTER OM646	OP4033 MERCEDES

	COMP. NO	MODEL	AERDIESEL
	<p>9702600190 9112302</p>		<p>OP4018 MERCEDES</p>
	<p>6562690001 3892690706 3892691606 3892692001</p>	<p>G3/70-4/4,24 Housing Top : 6562690001 Housing Bottom : 3892692001 Gear Inside Small : 3892691606 Gear Outside Big : 3892690706</p>	<p>OP4062 MERCEDES</p>
	<p>6562690001</p>	<p>HOUSING TOP G3/70-4/4,24</p>	<p>OP4025 MERCEDES</p>
	<p>3892690706</p>	<p>GEAR OUTSIDE BIG G3/70-4/4,24</p>	<p>OP4026 MERCEDES</p>
	<p>3892691606</p>	<p>GEAR INSIDE SMALL G3/70-4/4,24</p>	<p>OP4027 MERCEDES</p>

	COMP. NO	MODEL	AERDIESEL
	3892692001	HOUSING BOTTOM G3/70-4/4,24	OP4028 MERCEDES
	0002602790 0002602390 0002601390 0002601290 0002601190 0002600890 0002600790	MANUEL GEARBOX	OP7054 MERCEDES
	3892600690	G 210/ G 211/ G 230/ G 231/ G 240/ G 260 Housing Top : 9472691001 Housing Bottom : 9452690301 Gear Inside Small : 3892691506 Gear Outside Big : 3892690706 O-ring : 0299975748 Pin : 0019917860	OP4016 MERCEDES
	3892600790	G 131 / G 181 / G 230 Housing Top : 9472691001 Gear Inside Small : 3892691506 Gear Outside Big : 3892690706 Pin : 0019917860	OP4020 MERCEDES
	5422001701	Actros 1843 1848 1853 1857 2035 OM541 OM542	AW24050 MERCEDES

	COMP. NO	MODEL	AER DIESEL
	5412000101	Actros 1831 1835 1840 1853 2035 OM541 OM542	AW24090 MERCEDES
	9042000401 9042010201 9042004901 9042000601 9042000801 9042002601	Atego OM904	AW24120 MERCEDES
	A9062001401 9062006101 9062001401 9062002201 9062002911 9062005401	U3000, U5000, OM900 OM906	AW24180 MERCEDES
	9062006201 9062005501 9062003701 9062002801	OM904 LA, OM906 LA, OM924 LA, OM926 LA	AW24400 MERCEDES
	6112000501 6112001101 6112200110 A6112001101 5103576AB 5103576AA	2002-2003 Sprinter L5 2.7L	AW24340 MERCEDES





	COMP. NO	MODEL	AER DIESEL
	A3662000601	Bus/Truck OM366 1992-1986 OM256, OM366 (Short)	AW24360 MERCEDES
	A3662006801	OM366 (Long) OM366 1991-1993 (No Back Plate)	AW24370 MERCEDES
	A3662006801	OM366 (Long) OM366 1991-1993 (With Back Plate)	AW24371 MERCEDES
	9062006301 9062004001 9062005101 9062004301	OM906 LA, OM924 LA, OM926 LA	AW24200 MERCEDES
	EA4722000401	DD15	AW24410 MERCEDES





	COMP. NO	MODEL	AER DIESEL
	A3902000101	OM366 1979-1992 D-1521 Bus Marco-Polo	AW24380 MERCEDES
	RA4602000001	MBE 4000, MBE 460	AW24390 MERCEDES
	A6422001301 5138057AA 6472000101	2004-2007 Sprinter L5 2.7L	AW24350 MERCEDES
	A9062020710	BELT PULLEY 8 RIB	DP026 MERCEDES
	0040910501 0040911401 0030917401 0030915701 0030919901 0040910401	ATEGO AXOR OM 904LA OM 906LA OM 924LA	FP007 MERCEDES

	COMP. NO	MODEL	AER DIESEL
	0040911401	ATEGO AXOR NEW TYPE	FP109 MERCEDES
	0040910801 0040911101	AROCS	FP125 MERCEDES
	4570910601 4570910401	AXOR	FP008 MERCEDES
	4570910201	OM457, OM460 LONG TYPE	FP084 MERCEDES
	6110900350 6110900250 6110900150	VITO 2.2 CDI Vaneo 1.7 CDI SPRINTER 2t 208 / 211 / 213 / 216 CDI SPRINTER 3t 308 / 311 / 313 / 316 CDI SPRINTER 4t 408 / 411 / 413 / 416 CDI	FP054 MERCEDES





	COMP. NO	MODEL	AER DIESEL
	0000907350 0000900212	M14 x 1,5mm M14 x 1,5mm M14 x 1,5mm H: 102 mm Ø63mm	FP019 MERCEDES
	0010900350	M16 x 1,5mm M16 x 1,5mm CLOSED H: 102 mm Ø63mm	FP020 MERCEDES
	0000906050	CLOSED M14 x 1,5mm M14 x 1,5mm H: 102 mm Ø70mm	FP022 MERCEDES
	0000901450		FP027 MERCEDES
	0000901550 0000911401 0010919601 0440008995		FP086 MERCEDES BOSCH



	COMP. NO	MODEL	AER DIESEL
	0000900550	OM 402 OM 403	FP033 MERCEDES
	0003047051	DTA 466	FP026 MERCEDES
	0000903150 0030910601	O 303, O 304 O 404, O 405, O 407, O 408 OH SERIES	FP036 MERCEDES
	0000905350		FP059 MERCEDES
	0000903450 0440017994 0440017034	OM364	FP085 MERCEDES BOSCH

	COMP. NO	MODEL	AERDIESEL
	0000902150 0020914901	OM 421/A/LA OM 422/A/LA OM 423/A/LA OM 441/A/LA OM 442 OM 443	FP034 MERCEDES
	0000903050	OM 423 LA	FP035 MERCEDES
	0000900350		FP038 MERCEDES
	0000901050		FP039 MERCEDES
	0000907450		FP030 MERCEDES



	COMP. NO	MODEL	AERDIESEL
	0010916701		FP048 MERCEDES
	0030912701		FP060 MERCEDES
	0000908650	ATEGO / ATEGO 2 AXOR / AXOR 2 ECONIC UNIMOG CITARO CONECTO TOURINO	FP061 MERCEDES
	0000909250	OM 457	FP037 MERCEDES
	0009102190		FP031 MERCEDES

	COMP. NO	MODEL	AER DIESEL
	0000912190		FP058 MERCEDES
	0000900151	REPAIR KIT	FP032 MERCEDES
	RBB 9440080022		FP097 FREIGHTLINER
	3521800315 3211800133 3521800015	OM 314 OM 352 OM 352A	RV007 MERCEDES
	3529970366	OM 364 OM 364A OM 364LA OM 366 OM 366LA	RV008 MERCEDES

	COMP. NO	MODEL	AERDIESEL
 	4421800015 4221800015	OM 447A OM 447LA OM 449A	RV009 MERCEDES
 	3551800033	OM 355 OM 355 A OM 355LA	RV010 MERCEDES
 	5411800715	OM 402 / 403 OM 422 / 423 OM 443 / 444 OM 501 / 502	RV022 MERCEDES
 	4570700246	AXOR CITARO TRAVEGO OM 457 M16x1,5mm	RV024 MERCEDES
 	5410700646 5410700546 5410700246	AXOR 1840 ACTROS M16x1,5mm	RV025 MERCEDES

	COMP. NO	MODEL	AER DIESEL
	<p>9060921210 9060920510</p>	<p>AXOR 3228</p>	<p>RV027 MERCEDES</p>
	<p>5411800915</p>		<p>RV041 MERCEDES</p>
	<p>5410980057</p>		<p>RV083 MERCEDES</p>
	<p>0000747684 0000743884 0000746584 0000747684</p>	<p>OM355 / 360 / 364 / 366 / 407 / 422 / 423</p>	<p>RV026 MERCEDES</p>
	<p>0000740384 0000740484 0000747284</p>		<p>RV103 MERCEDES</p>

	COMP. NO	MODEL	AER DIESEL
 	0004770329	OM 326	RV028 MERCEDES
 	0000748584 0000920710		RV080 MERCEDES
 	0000740515	OM 314 / 352 / 360 / 364	RV029 MERCEDES
 	4429905563		RV084 MERCEDES
 	0000749984		RV051 MERCEDES

	COMP. NO	MODEL	AER DIESEL
	915047008100 915047008200 915047008209 915047008202		RV100 MERCEDES
	4570980357		RV081 MERCEDES
	9040980057 9040980557 5410980557 4570980057	ACTROS ATEGO AXOR	RV063 MERCEDES
	4570980257		RV082 MERCEDES
	9060910224		RV102 MERCEDES

	COMP. NO	MODEL	AERDIESEL
	2447010011	REPAIR KITS	FP107 BOSCH
	2447010021	REPAIR KITS	FP110 BOSCH
	2447010021SS	REPAIR KIT DIAMETER : 24.00 MM THREAD : 1/4-18NPTF	FP112 BOSCH
	2447010043	REPAIR KIT DIAMETER : 22.00 MM THREAD : 14.00 mm x 1.50 mm	FP113 BOSCH
	2447010021S	REPAIR KIT DIAMETER : 22.00 MM THREAD : 14.00 mm x 1.50 mm	FP114 BOSCH

COMP. NO

MODEL

AERDIESEL



2447010004



FP115
BOSCH



AERDIESEL
CONTINUOUS IMPROVEMENT

NAVISTAR

 aerdiesel.com

	COMP. NO	MODEL	AERDIESEL
	1842665C93 1842664C91 1842664C92	DT466 / DT530 / DT466E HEUI / DT530E	AW37010 NAVISTAR
	1889116C92 1889116C91	DT570 / MaxxForce	AW37020 NAVISTAR
	1817687C95 1817687C94 1817687C96 1817687C92 1830606C94 1830606C95	DT466 New Gen	AW37040 NAVISTAR
	52031251		FP069 NAVISTAR BOSCH
	212274R1 1812568C91 0440017040	DT466E HEUI/DT530E HEUI Engines	FP070 NAVISTAR MACK BOSCH

	COMP. NO	MODEL	AERDIESEL
	BA 130/95 0440001874	ALL	FP059 NAVISTAR BOSCH
	1821232 2601834C91 0440008134	ALL	FP074 NAVISTAR BOSCH
	440008174	DT-466E / DT-530E (1993-1999 HEUI)	FP096 NAVISTAR MACK
	1825511C1 1821272C1	DT466E HEUI/DT530E HEUI Engines	RV087 NAVISTAR MACK
	1833386C1	Year: 1993-2003 International DT530E HEUI/DT466E HEUI /530 Engines application	RV110 DETROIT





	COMP. NO	MODEL	AER DIESEL
	2447010043	REPAIR KIT DIAMETER : 22.00 MM THREAD : 14.00 mm x 1.50 mm	FP113 BOSCH
	2447010021S	REPAIR KIT DIAMETER : 22.00 MM THREAD : 14.00 mm x 1.50 mm	FP114 BOSCH
	2447010004		FP115 BOSCH



AER DIESEL
CONTINUOUS IMPROVEMENT

PACCAR

 aerdiesel.com

	COMP. NO	MODEL	AER DIESEL
	1942598 1942598PE	MX13 DAF	AW21110 PACCAR
	2447010021SS	REPAIR KIT DIAMETER : 24.00 MM THREAD : 1/4-18NPTF	FP112 BOSCH
	2447010043	REPAIR KIT DIAMETER : 22.00 MM THREAD : 14.00 mm x 1.50 mm	FP113 BOSCH
	2447010021S	REPAIR KIT DIAMETER : 22.00 MM THREAD : 14.00 mm x 1.50 mm	FP114 BOSCH
	2447010004		FP115 BOSCH



AERDIESEL
CONTINUOUS IMPROVEMENT

SCANIA

 aerdiesel.com

	COMP. NO	MODEL	AERDIESEL
	<p>10570951 1508533 1353072</p>	<p>Model 114 124 DSC 11 DCS 12</p>	<p>AW26010 SCANIA</p>
	<p>10570952 1508534 1365841</p>	<p>Model 114 DCS 14</p>	<p>AW26020 SCANIA</p>
	<p>1789522 1546188</p>	<p>124R 144R P-, G-, R-, T 4 LKW, 4 Bus F-, K-, N Bus</p>	<p>AW26030 SCANIA</p>
	<p>1787120</p>	<p>124R 144R P-, G-, R-, T 4 LKW, 4 Bus F-, K-, N Bus</p>	<p>AW26040 SCANIA</p>
	<p>2447010021SS</p>	<p>REPAIR KIT DIAMETER : 24.00 MM THREAD : 1/4-18NPTF</p>	<p>FP112 BOSCH</p>

	COMP. NO	MODEL	AER DIESEL
	2447010043	REPAIR KIT DIAMETER : 22.00 MM THREAD : 14.00 mm x 1.50 mm	FP113 BOSCH
	2447010021S	REPAIR KIT DIAMETER : 22.00 MM THREAD : 14.00 mm x 1.50 mm	FP114 BOSCH
	2447010004		FP115 BOSCH





AERDIESEL
CONTINUOUS IMPROVEMENT

VOLVO

 aerdiesel.com

	COMP. NO	MODEL	AER DIESEL
	20498514 85013394 85013231	D13	OP7052 VOLVO
	814 99 41	Model FL 12 D12 C	AW27090 VOLVO
	20431135 20713787 20734268 85000452 20713962	D11 & D13	AW27120 VOLVO
	3098697	Model N14 (Cummins)	AW34370 VOLVO
	85142304 20744939 20538845 3161436 7421615952 85124623 85142303 85151109	D11 & D13	AW36070 VOLVO

	COMP. NO	MODEL	AERDIESEL
	21067551 21067955 20752310 20749646 7421067551 7421067955 7420749646	FH FH12 FL12 FM FM12 NH12 B12 D 12 C D 12 D	FP002 VOLVO RENAULT
	21539993 20441871 20769469 20440372 8193842 7421539993 7420441871	FH12 FL12 FM12 NH12 B12 D 12 A D 12 B	FP003 VOLVO RENAULT
	21539988	BUSES	FP075 VOLVO
	2447010021SS	REPAIR KIT DIAMETER : 24.00 MM THREAD : 1/4-18NPTF	FP112 BOSCH
	2447010043	REPAIR KIT DIAMETER : 22.00 MM THREAD : 14.00 mm x 1.50 mm	FP113 BOSCH

	COMP. NO	MODEL	AER DIESEL
	2447010021S	REPAIR KIT DIAMETER : 22.00 MM THREAD : 14.00 mm x 1.50 mm	FP114 BOSCH
	2447010004		FP115 BOSCH



AERDIESEL

CONTINUOUS IMPROVEMENT

CONTINUOUS IMPROVEMENT

Oil Pumps - Water Pumps - Relief Valves - Fuel Pumps





AMERICAN APPLICATIONS

2022 - V2



AERDIESEL

CONTINUOUS IMPROVEMENT

CONTACT INFORMATION

Fevziçakmak Mah. 10693 Sk. 23/1 Karatay/Konya/TÜRKİYE
+90 332 502 00 99 | info@aerdiesel.com